

Above-Ground Petroleum Storage Tank Manual
With Data on NC Gasoline Vapor Recovery
&
EPA Spill Plan Information



By

The North Carolina Petroleum & Convenience Marketers
7300 Glenwood Avenue
Raleigh, North Carolina 27612
919-782-4411

Web site: www.ncpcm.org

Tim Laughlin, PE

Technical Affairs Director

Email: tloughlin@ncpcm.org

[Last update July 3, 2019](#)

The intent of this document is to provide information to NCPCM Petroleum Marketing Industry members. It will not serve as engineering design, permit approvals, construction documents, and equipment approvals or for any other purpose.

Definitions from the International Fire Code (IFC)

AUTOMOTIVE SERVICE STATION.

That portion of property where flammable or combustible liquids or gases used as motor fuels are stored and dispensed from fixed equipment into the fuel tanks of motor vehicles.

FLEET VEHICLE SERVICE STATION.

That portion of a commercial, industrial, governmental or manufacturing property where liquids used as fuels are stored and dispensed into the fuel tanks of motor vehicles that are used in connection with such businesses, by persons within the employ of such businesses.

MARINE SERVICE STATION.

That portion of property where flammable or combustible liquids or gases used as fuel for watercraft are stored and dispensed from fixed equipment on shore, piers, wharves, floats or barges into the fuel tanks of watercraft and shall include all other facilities used in connection therewith.

REPAIR GARAGE.

A building, structure or portion thereof used for servicing or repairing motor vehicles.

SELF-SERVICE STATION.

That portion of a service station where liquid motor fuels are dispensed from fixed approved dispensing equipment into the fuel tanks of motor vehicles by persons other than a service station attendant.

BULK PLANT OR TERMINAL.

That portion of a property where flammable or combustible liquids are received by tank vessel, pipelines, tank car or tank vehicle and are stored or blended in bulk for the purpose of distributing such liquids by tank vessel, pipeline, tank car, tank vehicle, portable tank or container.

BULK TRANSFER.

The loading or unloading of flammable or combustible liquids from or between tank vehicles, tank cars, or storage tanks.

FLASH POINT.

The minimum temperature in degrees Fahrenheit at which a liquid will give off sufficient vapors to form an ignitable mixture with air near the surface or in the container, but will not sustain combustion. The flash point of a liquid shall be determined by appropriate test procedure and apparatus as specified in ASTM D 56, ASTM D 93 or ASTM D 3278.

TANK, PRIMARY.

A listed atmospheric tank used to store liquid.

TANK, PROTECTED ABOVE GROUND.

A tank listed in accordance with UL 2085 consisting of a primary tank provided with protection from physical damage and fire-resistive protection from a high-intensity liquid pool fire exposure. The tank may provide protection elements as a unit or may be an assembly of components, or a combination thereof.

NFPA 30 2018 DEFINITION OF "FIRE RESISTANT TANK"

22.2.1 Fire-Resistant Tank. *An atmospheric aboveground storage tank with thermal insulation that has been evaluated for resistance to physical damage and for limiting the heat transferred to the primary tank when exposed to a hydrocarbon fuel fire and is listed in accordance with UL 2080, Standard for Fire Resistant Tanks for Flammable and Combustible Liquids, or an equivalent test procedure.*

Petroleum Products Fire Hazard Class

The Fire Codes have defined all petroleum products based upon their Flash Point. Flash Point is defined as the lowest temperature at which vapors from a volatile liquid will ignite momentarily upon the application of a small flame under specific conditions.

Flammable Liquid: A liquid having a flash point below 100°F and having a vapor pressure below 40 psia @ 100°F.

Class IA Liquid: Liquids with Flash Point below 73°F and Boiling Point below 100°F.

Class IB Liquid: Liquids with Flash Point below 73°F and Boiling Point above 100°F.

Class IC Liquid: Liquids with Flash Point above 73°F and below 100°F.

Combustible Liquid: A liquid having a flash point above 100°F.

Class II Liquid: Liquids with Flash Point above 100°F and below 140°F.

Class IIIA Liquid: Liquids with Flash Point above 140°F and below 200°F.

Class IIIB Liquid: Liquids with Flash Point above 200°F.

Fire Code Requirements of ASTs at Fleet Stations/C-Stores

The below drawing tries to clarify the minimum distance requirements for Aboveground Storage Tanks (ASTs) at public & private c-stores/service stations/marinas. This requires at least 40,000 square feet of area to install AST's at c-stores. Bear in mind that all new installations required fire code permits and professional engineers' seal. This change reflects the new International Fire Code effective in NC on January 1, 2002.

TYPICAL STORE LAYOUT

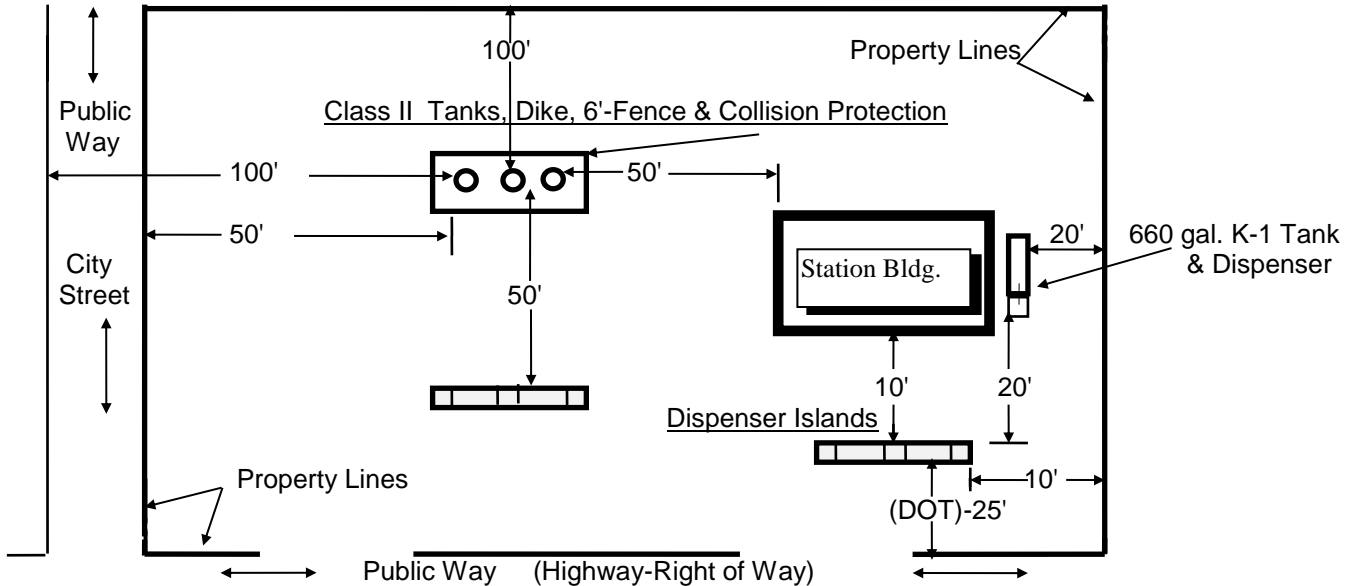

NO SCALE

All tanks must be UL labeled with maximum individual capacity of 12,000 gals., with total capacity limited at 48,000 gals. (Tanks in vaults can have up to 15,000 gals to 20,000 gals. individual capacity)

Liquid & Tank Type	Individual Tank Capacity (gallons)	Min. Distance From Nearest Important Building on Same Property (Feet)	Min. Distance From Nearest Fuel Dispenser	Min. Distance From Nearest Lot Line Which is or can be built upon, Including Opposite side of public way	Min. Distance From Nearest Side of Public Way	Min. Distance Between Tanks
Gasoline only allowed in protected tanks (UL2085)	Less than or equal to 6,000	5	25*	15	5	3
	Greater than 6,000 less than 12,000	15	25*	25	15	3
Diesel, Fuel Oil & Kerosene in protected tanks (UL 2085)	Same as Gasoline 12,000 gals. max.	Same as Gasoline	*Same as Gasoline	Same as Gasoline	Same as Gasoline	Same as Gasoline
Tanks in Vaults	0-20,000 gals.	0	0	0	0	Compartment
Other Tanks	12,000 gals.	50	50	100	50	3

*At commercial, industrial, governmental, or manufacturing establishments, (Fleet Vehicle Service Stations) where UL-2085 tanks are intended for fueling vehicles used in connection with their business, no minimum distance shall be required of the dispenser for gasoline, diesel, kerosene and fuel oil tanks. (See code change on small tanks under 1,100 gallons page 4)

1. Small Kerosene tanks (K-1) less than 660 gallons are exempt from the distance requirements and are installed per 2002 NC Fire Code section 2306.2.3.1.

2. Tanks also require liquid level gages and to alert attendant during unloading when tank reaches 90% of capacity alarm **and** stop product flow when the tank reaches 95% of capacity. The transport must be at least 25 feet from the tanks when unloading gasoline and 15 feet with diesel. NC Fire Prevention Code (IFC) Sections 2306.6.2.6 and 5704.2.9.6.8 requires a fixed 5 gallon spill container be attached to the fill pipe on top of tanks or portable spill containment will be allowed for tanks will remote fill connections. There are more requirements too numerous to enclose here (see NC Fire Code Chapters 23 & 57 or NFPA 30 & 30A). For more information please call Tim Laughlin at NCCPM.

3. Unattended service stations (Card Locks) with ASTs must be approved by the local authority having jurisdiction along with all emergency controls to provide a reasonable degree of safety in the absence of an attendant. See NC Fire Code section 2304.3

Fire Code Requirements on Double Wall ASTs

The below typical drawing is for double wall tanks installed at fleet service station, private installations and bulk petroleum storage tanks. A dike or some other form of secondary containment must be installed to provide for spill control.

1) ASTs at public fuel dispensing facilities and private fuel dispensing facilities means shall be provided for determining the liquid level in each tank and shall be accessible to the delivery operator. Means shall be provided to sound an audible/visual alarm when the liquid level in the tank reaches 90 percent capacity. Means shall also be provided to automatically stop the flow of liquid into the tank at 95 percent capacity. These provisions must not interfere with the normal operation of the normal or emergency vent. Gasoline (Class I) storage for dispensing to motor vehicles must be stored in a UL 2085 protected tank unless the following exemption: **Per NC FIRE CODE Section 2306.2.3 Above-ground tanks located outside, above grade. 6. Listed UL 142 above ground storage tanks with spill control, 1,100 gallons or less in capacity, may be used to store Class I liquids at fleet vehicle service stations.**

When the tank is at an elevation that produces a gravity head on the dispensing device, the tank outlet shall be equipped with a control device (such as a normally closed solenoid valve or property designed check valve) that will prevent gravity flow in the event of piping or dispenser failure.

2) ASTs installed at Bulk Petroleum Plants means shall be provided for determining the liquid level in each tank and shall be accessible to the delivery operator. Means shall be provided to sound an audible/visual alarm when the liquid level in the tank reaches 90 percent capacity. Means shall also be provided to automatically stop the flow of liquid into the tank at 95 percent capacity. These provisions must not interfere with the normal operation of the normal or emergency vent. (See page 12 for Changes to Bulk Storage Tank Overfill Prevention Code)

Pressure relief devices must be installed to prevent pressure build-up caused by thermal expansion.

The local authority having jurisdiction may grant alternate design considerations in accordance with NFPA -30 & 30A or NC Fire Code as the governing installation code.

ABOVEGROUND UL-2085 FLEET GASOLINE FUELING

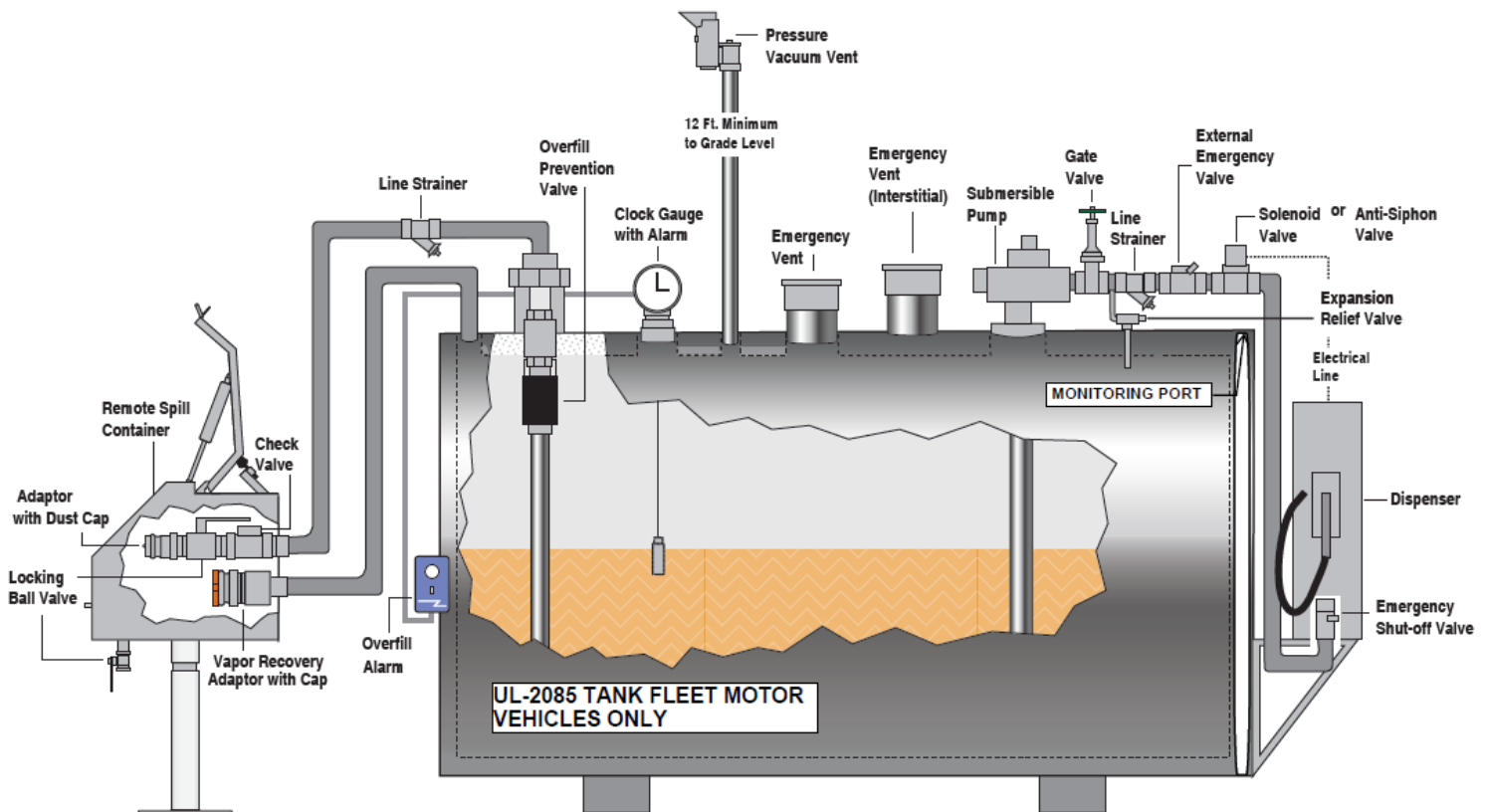

Fire Code Requirements on Public & Private Double Wall ASTs.

At C-stores, service stations, commercial, industrial, governmental, or manufacturing establishments, (Fleet Vehicle Refueling Facilities) where tanks are intended for fueling vehicles used in connection with their business, AST minimum distance will be accordance with the table on page 3. Gasoline storage for dispensing to motor vehicles is only allowed from a “**Fire Protected Tank, (UL2085) or Vaulted Tank** and no minimum distance is required of the dispenser for Fleet Facilities only.

“**Fire Resistant Tanks**” are tanks that meet UL Standard 2080 or **equivalent standard** under the new definition of NFPA 30A, 2018 edition. You can install **Fire Resistant Tanks** for aboveground use in accordance with the latest editions of NFPA 30A at Fire Officials prior approval, under “Alternative Design” requirements. All other requirements must be met. Please see the typical installation drawing below.

Small K-1 secondary containment type tanks at service stations need only comply with NC Fire Code section 2306.2.3.1 and K-1 piping connections below the liquid level need an internal emergency shear valve installed. Rain shields on integral diked tanks are considered to need emergency venting.

ABOVEGROUND PUBLIC MOTOR FUELING FOR GASOLINE

Aboveground Fuel Storage - Pressure System

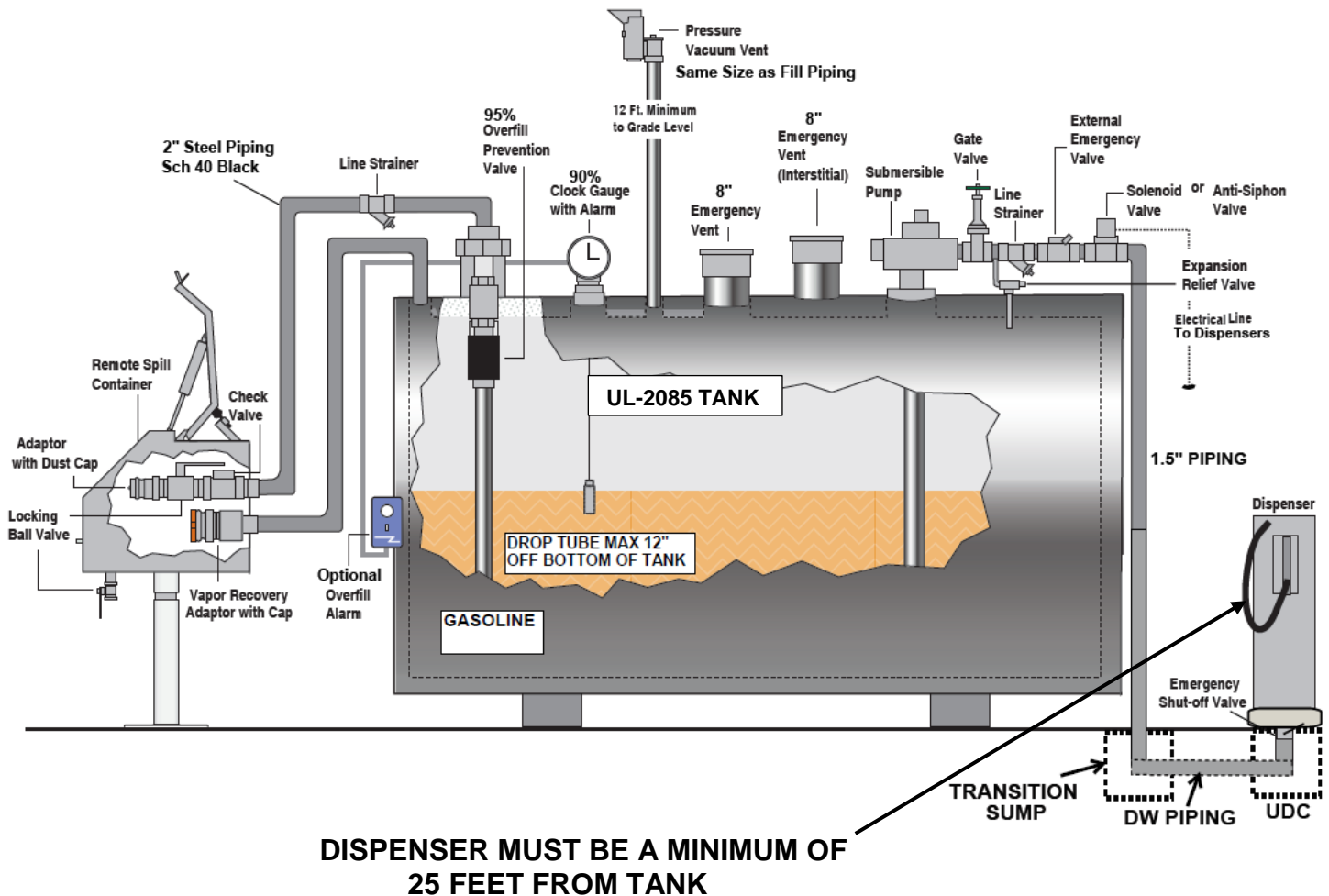

**ABOVEGROUND TANK-SUCTION SYSTEM
TOP FILL & TOP MOUNTED PUMP**

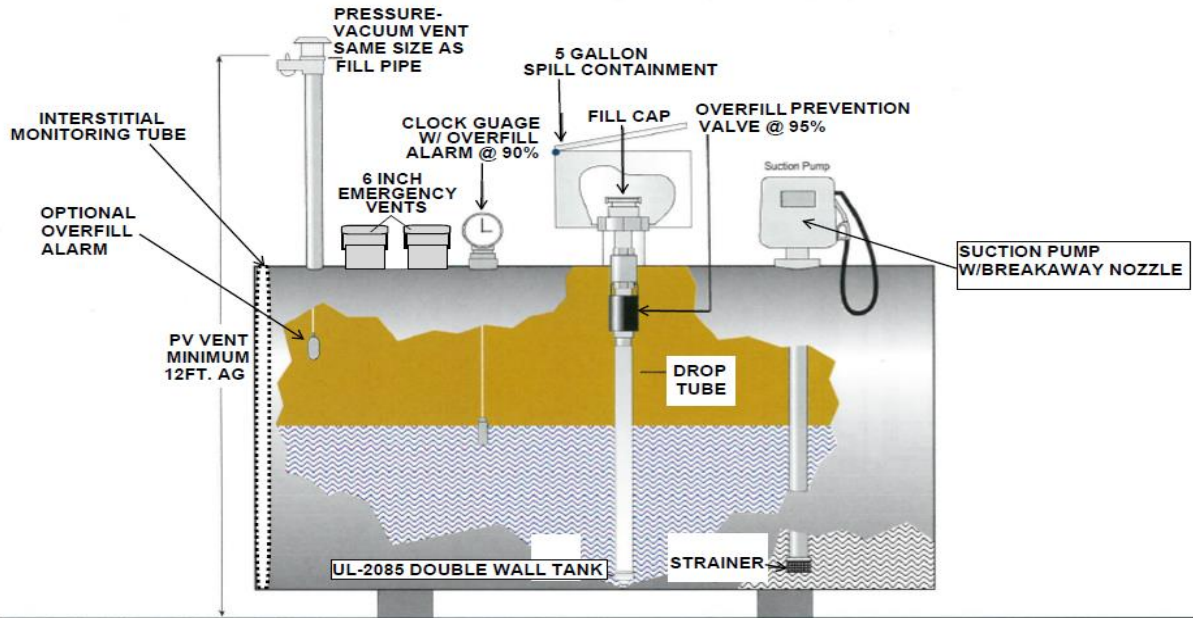

Aboveground Bulk Tanks with Remote Pump(s)

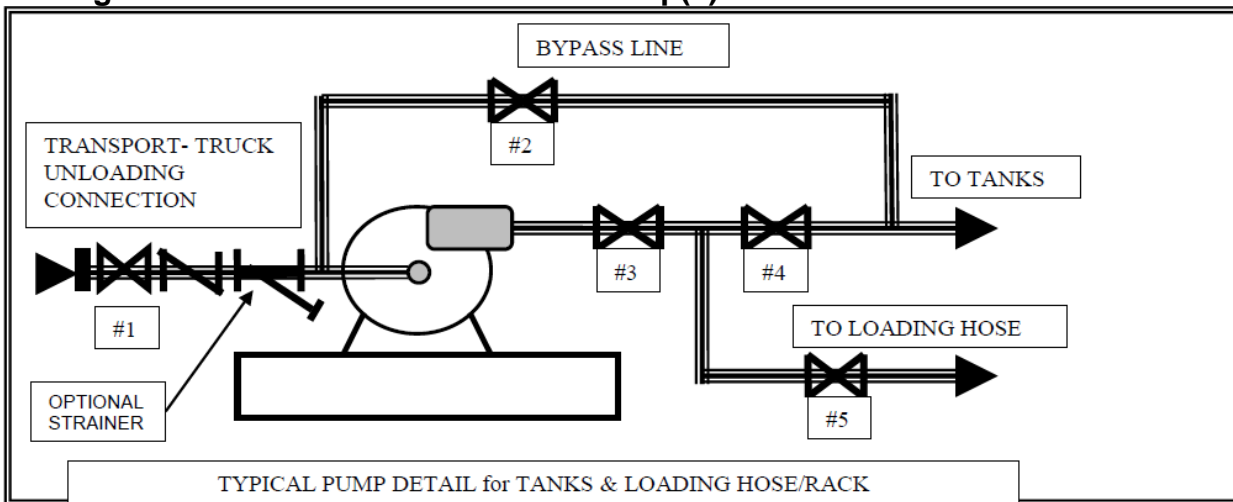

Valve Schedule and Sequence of Operations:

- I) Transport Unloading: Open Valves #1, #3 and #4, Close Valves #2 and #5. Turn pump on. NOTE: Special care shall be considered that loading operations to tank wagon vehicles cannot occur during transport off-loading. Additional Check Valves may be added to prevent flows opposite arrow direction.
- II) Loading Rack Operations: Close Valves #1 and #4, Open Valves #2, #3 and #5.
- III) Valve Schedule:
 - #1 Transport unloading valve normally closed, during loading rack operations.
 - #2 Bypass pump valve normally open, during loading rack operations.
 - #3 Pump discharge valve normally open, during loading rack & tanker unloading operations (OPTIONAL).
 - #4 Pump discharge/tank valve, normally closed during loading rack operations.
 - #5 Loading valve normally open, during loading rack operations.

NOTES: Positive displacement pumps shall be provided with pressure relief that discharges back to the tank, pump suction, or other suitable location or shall be provided with interlocks to prevent overpressure. Flexible connectors are used in piping systems wherever the connection would be subject to movement or vibration in normal use. Examples include connections between pumps and fixed piping and at piping headers where connections are made and broken. Piping systems shall contain valves to operate the system properly and to isolate the equipment in the event of an emergency. Piping systems in connection with pumps shall contain valves to properly control the flow of liquid both in normal operation and in the event of an emergency. Check valves are required only if backflow is possible. Liquid in any exposed portion of a pipe expands as ambient temperature increases and as a result of solar heating. Normally, thermal expansion is accommodated in the storage system. If a portion of exposed piping is blocked in at both ends by closed valves, however, thermal expansion results in an increase in pressure. Thermal blocking can result in dramatic increases in pressure with consequent leaks at fittings, joints, and seals. In extreme cases, thermal blocking has been known to cause failure of gaskets and seals and, in some cases, rupture of the piping.

Bulk Plant Fire Code AST's Minimum Distance Requirements

NFPA-30 and NC Building and Fire Codes govern the installation and distance requirements for bulk petroleum plants. NFPA-58 governs the installation of bulk LP-Gas tanks. The distances given are based on the quantity and type of petroleum products stored, other petroleum quantities would give different distance requirements. All tanks must be a minimum of 3 feet apart and should be at least 3 feet from dike wall if under 6ft in height. The dike floor must be sufficiently impervious by concrete, compacted clay, or other materials to prevent petroleum seepage in the event of a spill. Truck transports need at least a 50-foot turning radius and should not have to back-up on the property. Loading and unloading areas must be 25 feet away from tanks for Class I liquids (gasoline) and 15 feet away for Class II liquids (distillate) unless separated by fire proof barrier.

TYPICAL BULK PLANT INSTALLATION LAYOUT

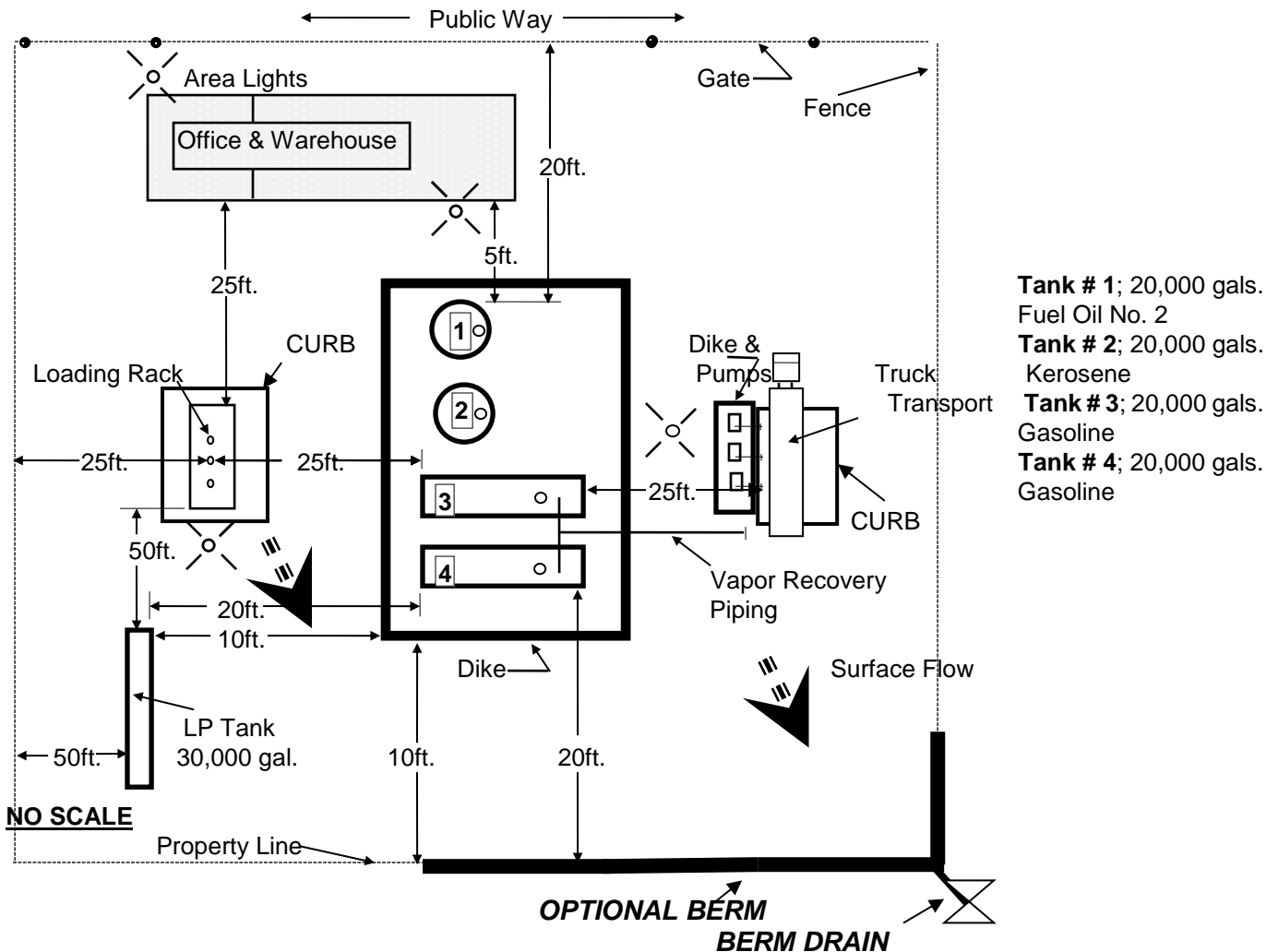

US EPA SPCC 40 CFR 112 Underground Piping Connected to any Regulated AST:

To prevent a discharge to navigable waters or adjoining shorelines, the SPCC rule requires that all piping (including buried piping) comply with the general secondary containment requirements contained in §112.7(c).

Any new or replaced underground piping (after 8-16-02) will meet the same standards as UST Regulation 40 CFR Part 280 or NC standards. Typically any new underground piping installed after August 16, 2002 from any regulated facility AST must be corrosion resistant double wall plastic or double wall fiberglass.

Additionally, any piping, equipment, or device not contained within secondary containment/Double Wall AST is subject to the general secondary containment requirements of §112.7(c). If a facility drainage system will be used to comply with secondary containment then the piping, equipment or device is also subject to requirements of §112.8(b) or §112.12(b).

ABOVEGROUND BULK PLANT TANK

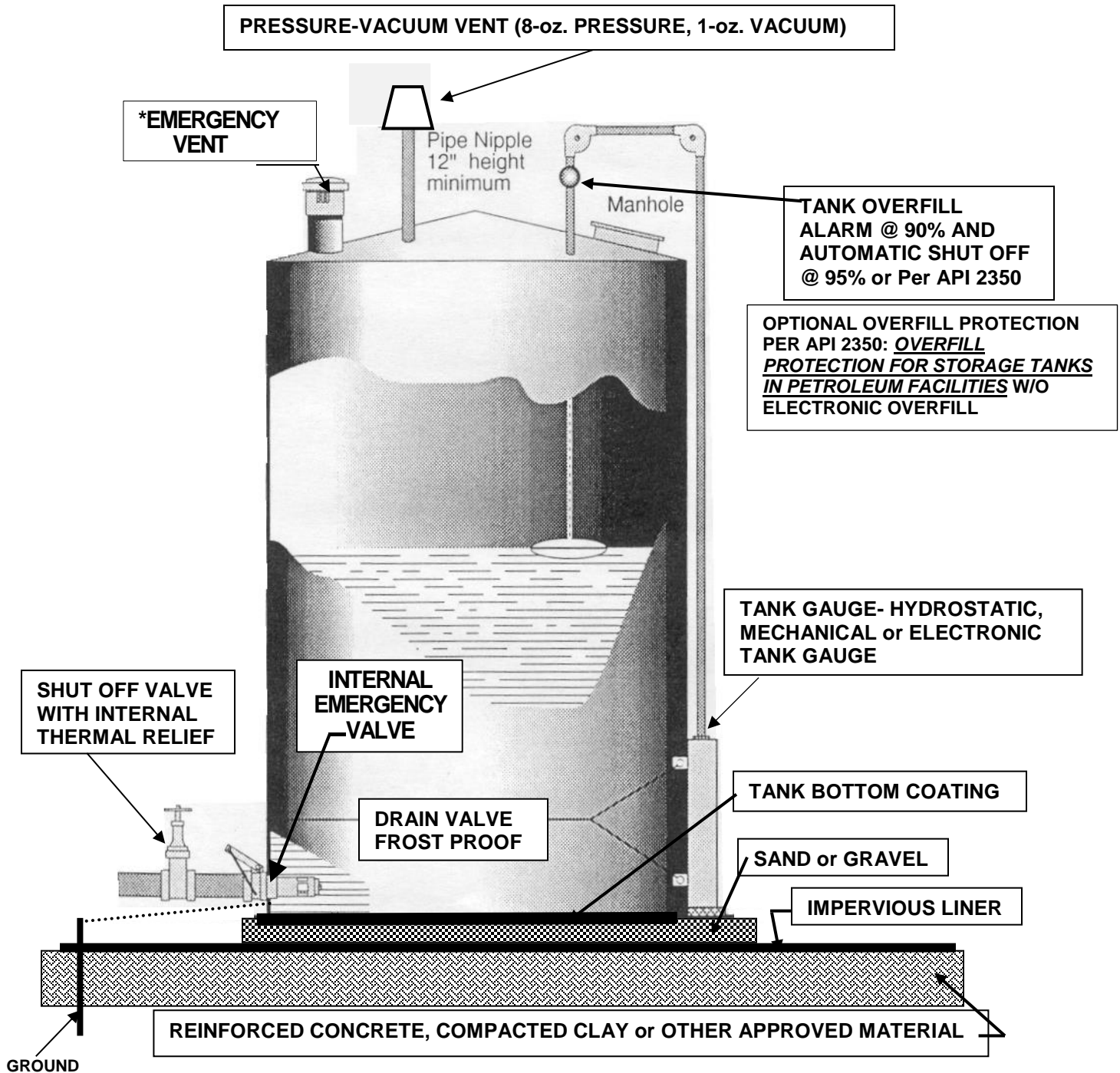

*Emergency relief venting consists of a manufactured emergency vent to relieve at approximately 2.5 psig pressure, or refer to liftable manhole covers, large diameter vents or weak roof to shell welds if either of these alternatives is used. NC Fire Prevention Code (IFC) Sections 2306.6.2.6 and 5704.2.9.6.8 requires a fixed 5 gallon spill container be attached to the fill pipe on top of tanks or portable spill containment will be allowed for tanks with remote fill connections.

Each tank must have a lockable valve on its main flow connection. Overfill prevention must be installed or in accordance with API 2350. Overfill prevention must be tested at regular intervals.

Water shall not pool around tank bottom. Horizontal tanks must be installed on approved foundations and masonry supports, fire protected steel supports are allowed.

SDS Data on Common Petroleum Products

The below table describes data one can find from a Safety Data Sheet (SDS). SDS's can be as long as 12 pages and contain much more data than given below. The below information is typical and taken from specific SDS's. For specific information on name brand products one should review the name brand products SDS's.

The table information is based on the following. 1) Density is at 60 degrees F. 2) Most petroleum products have flash points that have a degree range, for safety considerations please use the lowest flash point. 3) NFPA-704 color code is rated on numbers with 0 being the least cause for concern and 4 being the most cause for health and safety concerns. (B) stands for blue and is health rating, (R) stands for red and is fire rating, (Y) stands for yellow is for reactivity rating. 4) Gasolines contains no oxygenates and is standard RVP.

Chemical Type	Flash Point °F	Density lbs./gal.	Shipping DOT ID #	CAS #	NFPA-704 color code	Hazard Class
Gasoline 89 octane	-44	6.26	1203	8006-61-9	B-2, R-4, Y-0	Flammable
Diesel # 2	120-180	7.15	1993	68476-30-2	B-2, R-2, Y-0	Combustible
K-1 Kerosene	122-150	6.92	1223	8008-20-6	B-1, R-2, Y-0	Combustible
# 2 Fuel Oil	120-180	7.15	1993	68476-30-2	B-0, R-2, Y-0	Combustible
Motor Oil 10W-30	401	7.33	none	64741-88-4	B-0, R-1, Y-0	Combustible
Antifreeze Ethylene-Glycol	235	9.38	none	107-21-1	B-3, R-1, Y-0	non-flammable
Gasoline 87 octane	-44	6.23	1203	8006-61-9	B-2, R-4, Y-0	Flammable
Lube Oil 90 W	360	7.53	none	mixture	B-1, R-1, Y-0	Combustible
Soy Oil (B-100) Fatty Acid Ester	266 min.	7.3	none ID # 144920	Methyl Soyate: 67784-80-9; most common	B-0, R-1, Y-0	Combustible
Ethanol (200 proof)	50-60	6.5	1170	64-17-5	B-0, R-3, Y-0	Flammable
Propane Liquid or Gas	-156	4.2	1978	74-98-6	B-1, R-4, Y-0	Flammable Gas

NC FIRE CODE NFPA 704 LABELING

In accordance with Chapter 50, of the NC Fire Code, section 5003.5, all facilities that store, handle, or use hazardous materials in quantities in excess of the exempt amounts must post visible hazard identification signs as specified in the National Fire Protection Association's code 704. These Square-on-point colored signs must be posted at all entrances where hazardous materials are used or stored. Generally your most hazardous material will dictate the number codes as follows.

Each color will have a number from 0 (zero) to 4 (four) with zero meaning no harm under certain fire conditions and four meaning extremely dangerous for health, flammability, and reactivity. An example sign for motor oil (10W30) as follows.

NFPA® Hazard Rating:

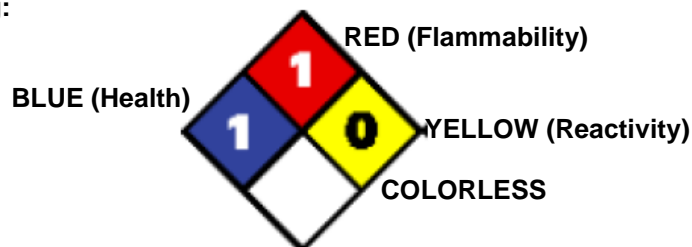

You can determine your most hazardous substance by checking your Safety Data Sheets (SDS). This regulation, also required by OSHA's Community Right to Know rules, covers all bulk plants and gasoline dispensing facilities. To order the appropriate signs, these phone numbers can be called 1-800-442-3633, 1-800-243-6642, 1-800-327-6868, and 1-800-521-7000.

Reuse or Abandonment of ASTs per Fire Code (IFC)

Consideration to exclude/exempt ASTs from the upcoming US EPA Spill Prevention Control & Countermeasure Plan (SPCC) requires that the AST be disconnected from the piping system. The AST shall be emptied, safeguarded and cap at piping connection point with a blind flange or other approved measure to protect the inside of the tank.

From 2018 IFC Code

5704.2.13.2 Above-ground tanks. Above-ground tanks taken out of service shall comply with Sections 5704.2.13.2.1 through 5704.2.13.2.3.

5704.2.13.2.1 Temporarily out of service. Aboveground tanks temporarily out of service shall have all connecting lines isolated from the tank and be secured against tampering.

Exception: In-place fire protection (foam) system lines.

5704.2.13.2.2 Out of service for 90 days. Aboveground tanks not used for a period of 90 days shall be safeguarded in accordance with Section 5704.2.13.1.2 or removed in accordance with Section 5704.2.14.

Exceptions:

1. Tanks and containers connected to oil burners that are not in use during the warm season of the year or are used as a backup heating system to gas.

2. In-place, active fire protection (foam) system lines.

5704.2.13.2.3 Out of service for one year. Aboveground tanks that have been out of service for a period of one year shall be removed in accordance with Section 5704.2.14.

Exception: Tanks within operating facilities.

5704.2.14.2 Disposal.

Tanks shall be disposed of in accordance with federal, state and local regulations.

5704.2.15 Maintenance. Above-ground tanks, connected piping and ancillary equipment shall be maintained in a safe operating condition. Tanks shall be maintained in accordance with their listings. Damage to above ground tanks, connected piping or ancillary equipment shall be repaired using materials having equal or greater strength and *fire resistance* or the equipment shall be replaced or taken out of service.

Emergency Venting is Required on All Tanks Storing Gasoline & Distillate Fuels & Some Hydraulic/Lubrication Oils

From UL-142 Steel Aboveground Tanks for Flammable and Combustible Liquids and NC Fire Code. Emergency venting is for Aboveground Storage Tanks that store Gasoline, Diesel, Kerosene, Fuel Oil (NA on Residential Fuel Tanks) and in some cases Hydraulic and Lubrication Oils (tanks under 12,000 gallons). **Do not tighten manhole bolts on tanks that use manholes for emergency venting. Do not attach anything to manholes that are use as emergency venting.**

UL-142 Section 8 Venting:

8.1 Each primary containment tank and each compartment of a compartment tank shall have provision for both normal and emergency venting. The openings for these vents shall be located at the top of the tank. The interstitial (annular) space of a secondary containment tank shall have provision for emergency venting. The opening for this emergency vent shall be located at the top of the secondary containment and shall terminate vertically above the top of the primary tank. These vent openings shall be in addition to the fill, withdrawal, and liquid level gauge openings.

8.2 The normal venting shall be sized in accordance with Table 8.2 and shall be at least as large as the filling or withdrawal connection, whichever is larger, but in no case less than 1-1/4 inch (30 mm) nominal inside diameter.

8.3 The provision for emergency venting shall be:

- a) An opening that complies with the requirements in 8.4 and is provided for that purpose only or
- b) A manhole with cover as described in 8.8 – 8.10 and a vent opening for normal venting complying with the requirements in 8.11.

8.8 A manhole in the top of a tank, with a cover constructed so as to lift under internal pressure such that the pressure in the tank cannot exceed a gauge pressure of 2.5 psig (17.2 kPa) may serve for emergency venting. Where emergency venting is provided by such manhole and cover, the tank shall include a vent opening for normal venting in accordance with the requirements in 8.11.

8.9 Emergency venting in accordance with 8.8 may be obtained by an arrangement such that the cover of a manhole not less than 16 inches (0.4 m) in diameter can be lifted vertically not less than 1-1/2 inches (38 mm) under conditions requiring emergency venting.

8.10 A long bolt manhole intended for emergency venting shall comply with Figure 9.1, except that the number of bolts and the number of holes may be reduced to one-half the number specified in Table 9.1. The bolts shall have an unthreaded section so that the cover can lift a minimum of 1-1/2 inches (38 mm).

NORMAL VENTING: MUST BE SIZED BASED ON FILL/WITHDRAWAL RATES.

Gasoline: Pressure/vacuum (PV) vent valves shall be installed on the storage tank vent pipes. The pressure specifications for PV vent valves shall be: a positive pressure setting of 2.5 to 6.0 inches of water and a negative pressure setting of 6.0 to 10.0 inches of water. The total leak rate of all PV vent valves at an affected facility, including connections, shall not exceed 0.17 cubic foot per hour at a pressure of 2.0 inches of water and 0.63 cubic foot per hour at a vacuum of 4 inches of water.

Typical Distillate Fuel Ranges: **PRESSURE = 2 to 16-oz./in² or 3.46 to 27.68 inches water column; VACUUM = 0.50 to 1 oz./in²**

NC Fire Code Changes Bulk Storage Tank Overfill Prevention Code

The NC-IFC Fire code on Flammable and Combustible Liquids storage tanks has changed the requirements on new bulk storage tanks under chapter 57 at bulk plants. This change does not apply to tanks used for the storage and dispensing to motorized equipment motorized vehicles under Chapter 23 or to tanks not located at the facilities listed below.

5704.2.7.5.8 Overfill prevention. An *approved* means or method in accordance with Section 5704.2.9.7.5 shall be provided to prevent the overfill of all Class I, II and IIIA liquid storage tanks. Storage tanks in refineries, bulk plants or terminals regulated by Section 5706.4 or 5706.7 shall have overfill protection in accordance with API 2350. An *approved* means or method in accordance with Section 5704.2.9.7.5 shall be provided to prevent the overfilling of Class IIIB liquid storage tanks connected to fuel-burning equipment inside buildings.

Exception: Outside above-ground tanks with a capacity of 1,320 gallons (5000 L) or less.

The American Petroleum Institute (API) recommended practice 2350 "Overfill Protection for Storage Tanks in Petroleum Facilities" is now required for all new bulk plant tanks after January 1, 2009.

Paraphrased from API 2350-Attended facilities (bulk plants) where electronic overfill detectors are not installed on tanks. Written procedures for product receipt shut down and diversion shall be developed by facility operator in accordance with API 2350.

Installation of electronic overfill detectors are not required for attended bulk plants. It is the facility operator decision on whether or not to install electronic systems.

The US EPA SPCC regulations do require electronic overfill prevention or equivalent environmental protection as prescribed by professional engineer.

Disaster Planning for Petroleum Storage Facilities

On September 16, 1999, Hurricane Floyd devastated Eastern NC. Floods created by two consecutive hurricanes in the fall of 2004 created severe damage throughout western NC. Many flooded areas were beyond the 500-year floodplain. For those of us involved in the design, construction and operation of fueling facilities, the effects of Hurricanes and Tropical Storms sound an alarm that there are serious problems that require attention. Disaster preparedness is knowing what to do both before and after the disaster and can be divided into four stages: (1) installation; (2) routine maintenance; (3) between the warning and the disaster (if time allows); and (4) after the disaster.

The latest edition of PEI RP200, Recommended Practices for Installation of Aboveground Storage Systems for Motor Vehicle Fueling, Section 2.16 "Emergency Planning"- It states: "In areas subject to flooding, make provisions to prevent tanks from floating. In areas subject to hurricanes or other significant storm events, make provisions to secure tanks against anticipated wind loading.... In all cases, consideration should be given to containment of releases."

In considering anchorage of USTs in areas subject to flooding, PEI RP100 states: "The calculation of tank buoyancy should be based on worst case conditions, that is, water level at finished grade and the tank empty." PEI's RP-800 RP for the Installation of Bulk Storage Plants, Section 4.11 requires anchoring for tanks in flood plains and plan on the accumulation of rainwater within a dike can cause tanks to float.

The NC Building Code requires the following: (from NFPA 30) **22.5.2.5-** Where a tank is located in an area subject to flooding, provisions shall be taken to prevent tanks, either full or empty, from floating during a rise in water level up to the established maximum flood stage. (See 21.7.3.)

21.7.3 Storage Tanks in Areas Subject to Flooding.

21.7.3.1 Water Loading.

21.7.3.1.1 The filling of a tank to be protected by water loading shall be started as soon as floodwaters are predicted to reach a dangerous flood stage.

21.7.3.1.2 Where independently fueled water pumps are relied on, sufficient fuel shall be available at all times to permit continuing operations until all tanks are filled.

21.7.3.1.3 Tank valves shall be locked in a closed position when water loading has been completed.

21.7.3.2 Operating Instructions. Operating instructions or procedures to be followed in a flood emergency shall be available to personnel identified in 21.7.3.3.

21.7.3.3 Personnel Training. Personnel relied on to carry out flood emergency procedures shall be informed of the location and operation of valves and other equipment necessary to effect the intent of these requirements.

Responding to warnings:

For hurricanes and floods, however, there may be enough advance warning to take some actions without jeopardizing personal safety and protection. If time allows:

- Record manual or automatic tank gauge readings of the tank before you take it out of service.
- Check fill caps and adapters for tightness, and make sure they are locked in place.
- Check any other possible openings where water could enter, including the interstitial space of a double wall tank.
- If there is a ball valve or other block valve on the product piping at the submerged pump, close and secure it.
- At the dispensers, close all impact/emergency valves by tripping the lever. Even if your dispensers don't get submerged, the force of flood waters or other floating objects could knock dispensers loose.
- Turn off all power to pumps and dispensers, automatic tank gauges and other components.
- For USTs, the product level in the tank doesn't matter as long as you are sure they have adequate anchorage to prevent floating. Consider filling the tanks with product if you are uncertain that your tanks are anchored. However, the risk you take is that no matter what you do, you cannot ensure the integrity of the system, and water may enter the tanks and displace product into the environment.
- If there is any possibility that flood levels could reach higher than the tank vents (12 feet), extend them with PVC pipe or other means.
- Unit aboveground storage tanks (steel tanks mounted in their own steel containment dikes) should have the dike drainage valves opened. This will allow flood waters to enter the diked area to help keep the unit tank from moving. (Close drain ASAP after flood event)

Aboveground Storage Tank(s) Registration

Reminder: North Carolina General Statute 143-215.96 requires the registration of "Oil Terminal Facilities". An Oil Terminal Facility is defined as any non-retail facility storing more than 21,000 gallons of petroleum product. This would include all bulk plants in North Carolina. This is an old regulation and most of you have already complied with it.

AST owners are required to submit the following information for registration:

- Complete name of owner & operator of the facility together with addresses and telephone numbers;
- Number of employees of the facility and principal officers; Maps or sketches to show property lines of the facility & location of nearby watercourses or bodies of water; and
- Procedures for the prevention of oil spills.

Your SPCC Plan can be used to meet these requirements. For a copy of the Oil Terminal Facility registration form check NCPCCM's web site or download from NC Groundwater's page at:

<https://deq.nc.gov/about/divisions/waste-management/ust/oil-terminal-facilities>

State Fire Code Required Permits

The North Carolina Fire Code, Chapter 1, Administration, section **105.6.17 Flammable and combustible liquids require** a mandatory operational permit the following:

- To operate tank vehicles, equipment, tanks, plants, terminals, wells, fuel-dispensing stations, refineries, distilleries and similar facilities where flammable and *combustible liquids* are produced, processed, transported, stored, dispensed or used.
 - To place temporarily out of service (for more than 90 days) an underground, protected above-ground or above-ground flammable or *combustible liquid* tank.
 - To change the type of contents stored in a flammable or *combustible liquid* tank to a material that poses a greater hazard than that for which the tank was designed and constructed.
 - To manufacture, process, blend or refine flammable or *combustible liquids*.
 - To engage in the dispensing of liquid fuels into the fuel tanks of motor vehicles at commercial, industrial, governmental or manufacturing establishments.
 - To utilize a site for the dispensing of liquid fuels from tank vehicles into the fuel tanks of motor vehicles, marine craft and other special equipment at commercial, industrial, governmental or manufacturing establishments.

From NC FIRE CODE: 105.7.8 Flammable and combustible liquids. A construction permit is required:

1. To install, repair or modify a pipeline for the transportation of flammable or *combustible liquids*.
2. To install, construct or alter tank vehicles, equipment, tanks, plants, terminals, wells, fuel-dispensing stations, refineries, distilleries and similar facilities where flammable and *combustible liquids* are produced, processed, transported, stored, dispensed or used. Maintenance performed in accordance with this code is not considered an

installation, construction or alteration and does not require a permit.

3. To install, alter, remove, abandon or otherwise dispose of a flammable or *combustible liquid* tank.

The Local Authority having Jurisdiction (AHJ) has the authority to require permits required under 105.7.7. It is also important to remember that the NC State Board of Registration for Professional Engineers and Land Surveyors require that a Professional Engineer (PE) seal all plans regarding ASTs/USTs Installations, piping, ancillary equipment upgrades, and vapor recovery system installations. Small Tanks of 1,100 gals. or less capacity for commercial or non-commercial purposes and tanks used for storing heating oil for consumptive use on the premises where stored and the storage of Class IIIB combustibles are excluded from the PE rule.

API 653/650 Storage Tank Inspections

American Petroleum Institute (API) standards 650 and 653 normally applied to aboveground petroleum storage tanks above 50,000 gallons and built on site. ASTs below 50,000 gallons are normally built at a factory site and are generally Underwriters Labs certificate. API 650 inspections can be used for both classifications.

How often, and to what detail, petroleum storage tanks should be inspected varies greatly. What is stored in the tank... Corrosion rate... location... risk... conditions at previous inspection... local regulations... to name a few. Normally, tanks that are constructed according to API 650 and are in service in mild conditions should be inspected according to a schedule set up at the time of construction and a record kept of such inspections, including and modifications or change of service. A detailed history of tank modifications and repairs is a must.

EXTERNAL: Routine in service inspections shall be conducted monthly. A close visual inspection from the ground will be conducted each month. The inspection may be conducted by the owner/operator who is thoroughly familiar with the facility and its operation. (SEE SPCC PLAN) The inspector should look for; leaks... bulges... corrosion... settlement... breaks in coating... insulation and appurtenances... monitor cathodic protection systems.

SCHEDULED INSPECTIONS: Scheduled external inspections shall be performed by an API 653 inspector at intervals not to exceed five years or at the quarter corrosion point, whichever is less. The API inspector will perform all the inspections as above. The corrosion rate will be determined, and grounding devices will be tested.

INTERNAL: Internal inspections are performed primarily to check the bottom plates for corrosion and leaks. Internal inspections are scheduled according to the corrosion rate, but not to exceed twenty years.

In December, 1996, three ASTs at three different bulk plants in NC failed and released product due to internal and external corrosion. All of these tanks were below 50,000 gallons and one of these tanks was of the horizontal type that did not touch the ground. It is very important to inspect all ASTs for corrosion, especially ones over 20 years old.

Corporate Farm ASTs May be Regulated by Fire Codes

Heating oil tank installations on farms are excluded from the NC Fire Codes & NFPA Pamphlet 31. However, farmers who lease/rent their farms to others or who have farms within the jurisdiction of any municipality are required to meet NC and/or NFPA Fire Codes. Any tank greater than 1,320 gallons is required to have secondary containment and a spill plan under Federal EPA regulations. Regarding a May 15, 2002, memo from the NC Dept. of Insurance, Farmers who store motor fuel for dispensing to vehicles from aboveground storage tanks less than 1,100 gallons in storage capacity may be excluded from the fire code requirements of NC Fire Code Chapters 57, section 5706.2. ASTS over 1,100 gallons may also be excluded from complying with section 5704.2. Farm heating oil tanks **should** comply with NFPA 31 and the NC Fire Code section 603.3.

U.S. EPA 10 GALLON PER MINUTE (GPM) NOZZLE REGULATION

US EPA regulation 40 CFR 80.22 (j) states that all retailer and wholesaler purchaser-consumer who dispenses gasoline or methanol into a motor vehicle at a facility handling more than 10,000 gallons of gasoline a month must limit the gasoline nozzle flow to 10 GPM by July 1, 1996. All gasoline dispenses handling under 10,000 gallons of gasoline per month must comply with this rule by January 1, 1998. Flow limits or flow restrictors must be installed in each case where the gasoline dispensing nozzle flow rates are greater than 10 GPM. The US EPA will enforce this regulation with their own inspectors, and violators can be fined up to \$25,000 per violation plus economic benefit. This rule is designed to control ambient air pollution (spit back) from motor vehicles during refueling and help the on-board vapor recovery canister being implemented on new motor vehicles starting with model year 1998.

NOZZLE FLOW RATE TESTING. A procedure for flow rate testing to be followed by **Federal EPA Inspectors** follows. Basically the dispenser closest to the tanks or pumps will be used for the test. Testing procedure is basically measuring the time to dispense 2.00 gallons of fuel with a digital stop watch that can read to the least 0.01 seconds into a calibrated 5 gallon proving fuel container.

TEST PROCEDURE: 1) If no vehicles are fueling, use the 5 gallon container. Start the stop watch when the dispenser indicates 1.00 gallons dispense. 2) Carefully measure the time with the stopwatch that it takes to dispense exactly 2.00 gallons of fuel. (i.e., stop the stopwatch when the dispenser indicates 3.00 gallons dispensed) 3) If the time is greater than 11.8 seconds, there is no violation. (there is a 0.2 second test tolerance) 4) If the time is less than or equal to 11.8 seconds repeat the test for another 2.00 gallons. If the second test is either less than or equal to 11.8 seconds, use the 5.0 gallon container to verify the accuracy of the dispenser meter. If the volume dispensed, when the meter shows 5.00 gallons, is more than 6 cubic inches over or under the five gallon mark, note this on the inspection form. If the volume of the container is 5.00 gallons or greater, note as a violation. If the volume is less than the 5.00 gallons by 6 cubic inches, conduct the test on another dispenser unit. The following volumes and times may be used; 2.00gals.@11.8 sec., 3.00gals.@17.7 sec., 4.00gals.@ 23.6 sec., 5.00gals.@29.5 sec.

Fire Code Allows Latch-Open or Latchless Devices on Hose Nozzles Based on Type of Facility

The motoring public detests standing in the rain, wind or snow to manually hold open the gasoline nozzle to deliver fuel to their vehicle. Some people have used various devices at hand (Bic-Lighters, gas caps, cola cans) to defeat the latchless nozzles. This in turn would override the automatic-closing nozzle while the customer shopped or cleaned their windshield. Some individuals have marketed a device that holds open the nozzle for one's personal use and many others have "homemade" devices. Keep in mind that some local ordinances may prevent latch-open devices, always check with the local Fire Official. The NC Fire Code (IFC) allows the use of latch-open devices for use on island types self-service gasoline dispensers. The Code is as follows:

From NC Fire Code:

2306.7.6 Fuel delivery nozzles. A *listed* automatic-closing type hose nozzle valve **with or without a latch-open device** shall be provided on island-type dispensers used for dispensing Class I, II or IIIA liquids.

Overhead-type dispensing units shall be provided with a *listed* automatic-closing-type hose nozzle valve without a latch-open device.

Exception: A *listed* automatic-closing-type hose nozzle valve with latch-open device is allowed to be used on overhead-type dispensing units where the design of the system is such that the hose nozzle valve will close automatically in the event the valve is released from a fill opening or upon impact with a driveway.

2306.7.6.1 Special requirements for nozzles. Where dispensing of Class I, II or IIIA liquids is performed, a *listed* automatic-closing-type hose nozzle valve shall be used incorporating all of the following features:

1. The hose nozzle valve shall be equipped with an integral latch-open device.
2. When the flow of product is normally controlled by devices or equipment other than the hose nozzle valve, the hose nozzle valve shall not be capable of being opened unless the delivery hose is pressurized.

If pressure to the hose is lost, the nozzle shall close automatically.

Exception: Vapor recovery nozzles incorporating insertion interlock devices designed to achieve shutoff on disconnect from the vehicle fill pipe.

3. The hose nozzle shall be designed such that the nozzle is retained in the fill pipe during the filling operation.
4. The system shall include *listed* equipment with a feature that causes or requires the closing of the hose nozzle valve before the product flow can be resumed or before the hose nozzle valve can be replaced in its normal position in the dispenser.

SECTION 2310 MARINE MOTOR FUEL-DISPENSING FACILITIES

2310.3 Dispensing. The dispensing of liquid fuels at marine motor fuel-dispensing facilities shall comply with Sections 2210.3.1 through 2210.3.5.

2310.3.1 General. Wharves, piers or floats at marine motor fuel-dispensing facilities shall be used exclusively for the dispensing or transfer of petroleum products to or from marine craft, except that transfer of essential ship stores is allowed.

2310.3.2 Supervision. Marine motor fuel-dispensing facilities shall have an attendant or supervisor who is fully aware of the operation, mechanics and hazards inherent to fueling of boats on duty whenever the facility is open for business. The attendant's primary function shall be to supervise, observe and control the dispensing of Class I, II or IIIA liquids or flammable gases.

2310.3.3 Hoses and nozzles. Dispensing of Class I, II or IIIA liquids into the fuel tanks of marine craft shall be by means of an *approved-type* hose equipped with a *listed* automatic-closing nozzle **without a latch-open device.** Hoses used for dispensing or transferring Class I, II or IIIA liquids, when not in use, shall be reeled, racked or otherwise protected from mechanical damage.

2310.3.4 Portable containers. Dispensing of Class I, II or IIIA liquids into containers, other than fuel tanks, shall be in accordance with Section 2204.4.1.

FIRE CODE DISPENSER REQUIREMENTS

We have received reports that some dispensers are being moved, jarred, or jilted by various accidents. When this happens the Fire/Impact valve not properly installed will sometimes not operate as designed and will spill petroleum products. The NC Fire Code section 2306.7.3 requires that all dispensers to be firmly and securely fastened to the island or ground. Also, NC Fire Code section 2306.7.4 requires that the Fire/Impact shear valve shall be **rigidly anchored** to the island or other secure methods for it to work properly. The shear section of the Fire/Impact shear valve should be installed within 1/2 inch of the dispenser island level. All dispensers shall be mounted on a concrete island (minimum of 6 inches in height) or otherwise protected against collision damage in accordance with NC Fire Code section 312. Dispensers shall be located in a position where a vehicle cannot strike it that is out of control descending a ramp or other slope. It is NCPDM's advice that all dispensers that are not properly anchored or have an improper Fire/Impact valve installed, correct these problems at the earliest possible time.

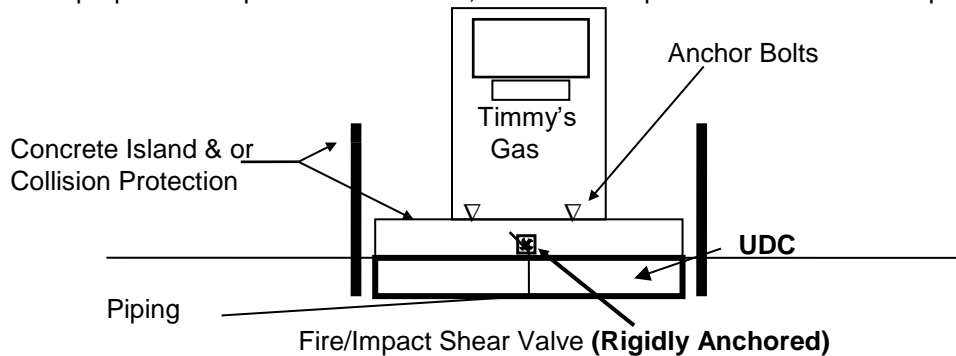

IFC/NC Fire Code Require Emergency Disconnect Switches at all Public Motor Fuel Dispensing Facilities

Since the mid 1980's all service stations, convenience stores, and other motor fuel dispensing facilities have been required to install emergency disconnect switch.

IFC Fire Code Section 2303.2 Emergency disconnect switches.

An approved, clearly identified and readily accessible emergency disconnect switch shall be provided at an approved location, to stop the transfer of fuel to the fuel dispensers in the event of a fuel spill or other emergency. An emergency disconnect switch for exterior fuel dispensers shall be located within 100 feet (30 480 mm) of, but not less than 20 feet (6096 mm) from, the fuel dispensers. For interior fuel-dispensing operations, the emergency disconnect switch shall be installed at an approved location. Such devices shall be distinctly labeled as: EMERGENCY FUEL SHUTOFF. Signs shall be provided in approved locations.

NC FIRE CODE Requires Annual Testing of Dispenser Emergency Shutoff Valve.

The code language is as follows: 2306.7.4 Dispenser emergency valve.

An approved emergency shutoff valve designed to close automatically in the event of a fire or impact shall be properly installed in the liquid supply line at the base of each dispenser supplied by a remote pump. The valve shall be installed so the shear groove is flush with or within 0.5 inch (12.7 mm) of the top of the concrete dispenser island and there is clearance provided for maintenance purposes around the valve body and operating parts. The valve shall be installed at the liquid supply line inlet of each overhead-type dispenser. Where installed, a vapor return line located inside the dispenser housing shall have a shear section or approved flexible connector for the liquid supply line emergency shutoff valve to function. Emergency shutoff valves shall be installed and maintained in accordance with the manufacturer's instructions, tested at the time of initial installation and tested at least yearly thereafter in accordance with Section 2305.2.2.

2305.2.2 Emergency shutoff valves. Automatic-closing emergency shutoff valves required by Section 2306.7.4 shall be checked not less than once per year by manually tripping the hold-open linkage.

Vehicle Impact Protection for Tanks & Dispensers-

From NC Fire Code:

2306.4 Physical protection. Guard posts complying with [Section 312](#) or other *approved* means shall be provided to protect above-ground tanks against impact by a motor vehicle unless the tank is *listed* as a protected above-ground tank with vehicle impact protection.

2306.7.3 Mounting of dispensers. Dispensing devices, except those installed on top of a protected above-ground tank that qualifies as vehicle-impact resistant, shall be protected against physical damage by mounting on a concrete island 6 inches (152 mm) or more in height, or shall be protected in accordance with [Section 312](#). Dispensing devices shall be installed and securely fastened to their mounting surface in accordance with the dispenser manufacturer's instructions. Dispensing devices installed indoors shall be located in an *approved* position where they cannot be struck by an out-of-control vehicle descending a ramp or other slope.

SECTION 312 VEHICLE IMPACT PROTECTION

312.1 General. Vehicle impact protection required by this code shall be provided by posts that comply with Section 312.2 or by other *approved* physical barriers that comply with Section 312.3.

312.2 Posts. Guard posts shall comply with all of the following requirements:

1. Constructed of steel not less than 4 inches (102 mm) in diameter and concrete filled.
2. Spaced not more than 4 feet (1219 mm) between posts on center.
3. Set not less than 3 feet (914 mm) deep in a concrete footing of not less than a 15-inch (381 mm) diameter.
4. Set with the top of the posts not less than 3 feet (914 mm) above ground.
5. Located not less than 3 feet (914 mm) from the protected object.

312.3 Other barriers. Physical barriers shall be a minimum of 36 inches (914 mm) in height and shall resist a force of 12,000 pounds (53 375 N) applied 36 inches (914 mm) above the adjacent ground surface.
(end of code)

Basically, other barriers example would involve a head on impact from a 3,200 pound vehicle, with a velocity of 5 MPH at 3 feet above grade and the barrier wall/guard rail may move up to 6 inches or be destroyed. The barrier wall would be constructed of steel reinforced formed concrete walls (4000 psi @ 6 inches thick) or steel reinforced solid fill concrete block walls (8 inches thick) or steel guard rails. Barrier walls shall be installed on steel reinforced footing (24 inches wide x 14 inches thick) buried at least 24 inches below grade on compacted earth.

Tank Vehicles and Vehicle Operation Fire Codes

5706.5.4 Dispensing from tank vehicles and tank cars.

5706.5.1.1 Location. Bulk transfer and process transfer operations shall be conducted in approved locations. Tank cars shall be unloaded only on private sidings or railroad-siding facilities equipped for transferring flammable or combustible liquids. Tank vehicle and tank car transfer facilities shall be separated from buildings, above-ground tanks, combustible materials, lot lines, streets, alleys or public ways by a distance of 25 feet (7620 mm) for Class I liquids and 15 feet (4572 mm) for Class II and III liquids measured from the nearest position of any loading or unloading valve. Buildings for pumps or shelters for personnel shall be considered part of the transfer facility.

5706.5.1.18 Security. Transfer operations shall be surrounded by a noncombustible fence not less than 5 feet (1524 mm) in height. Tank vehicles and tank cars shall not be loaded or unloaded unless such vehicles are entirely within the fenced area. **Exceptions:**

1. **Motor vehicle service stations complying with [Chapter 23](#).**
2. **Installations where adequate public safety exists because of isolation, natural barriers or other factors as determined appropriate by the code official.**
3. **Facilities or properties that are entirely enclosed or protected from entry.**

5706.6 Tank vehicles shall be designed, constructed, equipped and maintained in accordance with NFPA 385 and [Sections 5706.6.1](#) through [5706.6.4](#).

5706.6.1.2 Leaving vehicle unattended. The driver, operator or attendant of a tank vehicle shall not remain in the vehicle cab and shall not leave the vehicle while it is being filled or discharged. The delivery hose, when attached to a tank vehicle, shall be considered to be a part of the tank vehicle.

5706.6.1.3 Vehicle motor shutdown. Motors of tank vehicles or tractors shall be shut down during the making or breaking of hose connections. If loading or unloading is performed without the use of a power pump, the tank vehicle or tractor motor shall be shut down throughout such operations.

5706.6.1.5 Overfill protection. The driver, operator or attendant of a tank vehicle shall, before making delivery to a tank, determine the unfilled capacity of such tank by a suitable gauging device. To prevent overfilling, the driver, operator or attendant shall not deliver in excess of that amount.

5706.6.2.1 Parking near residential, educational and institutional occupancies and other high-risk areas.

Tank vehicles shall not be left unattended at any time on residential streets, or within 500 feet (152 m) of a residential area, apartment or hotel complex, educational facility, hospital or care facility. Tank vehicles shall not be left unattended at any other place that would, in the opinion of the fire chief, present an extreme life hazard.

5706.6.2.2 Parking on thoroughfares. Tank vehicles shall not be left unattended on a street, highway, avenue or alley.

5706.6.4 Fire protection. Tank vehicles shall be equipped with a fire extinguisher complying with [Section 906](#) and having a minimum rating of 2-A:20-B:C. During unloading of the tank vehicle, the fire extinguisher shall be out of the carrying device on the vehicle and shall be 15 feet (4572 mm) or more from the unloading valves.

NC DOT Right of Way Dispenser Pump Setbacks.

NC DOT Right of Way set back requirements can be found in the “Policy on Streets and Driveway Access” manual. Pages 52 and 76 of this manual discusses gasoline dispenser set back requirements from DOT Right of Way. Set Backs (G) - Set backs, G, of gasoline pump islands parallel to the pavement edge shall be a minimum of 25 feet outside the highway right-of-way. Set backs of gasoline pump islands not parallel to the pavement edge shall be a minimum of 50 feet outside the highway right-of-way. The Manual can be downloaded at <https://connect.ncdot.gov/projects/Roadway/RoadwayDesignAdministrativeDocuments/Policy%20on%20Street%20and%20Driveway%20Access.pdf>

SPILL PREVENTION CONTROL AND COUNTERMEASURE PLANS

The US EPA Federal Regulation 40 CFR part 112 requires that a Spill Prevention Control and Countermeasure Plan (SPCC) be prepared for all onshore and offshore oil storage facilities that have discharged (spilled) oil or could reasonably be expected to discharge oil that would likely reach “navigable water”. The requirement for the SPCC Plan applies to non-vehicle or non-pipeline facilities involving storage facilities where any single above ground tank is larger than 1,320 gallons or the aggregate total above ground storage is over 1,320 gallons. There are virtually no exemptions or exceptions from the applicability requirement, according to the EPA and most facilities are included.

The SPCC Plan must be certified by a registered engineer, signed for validation by an authorized representative of the applicable facility, and all provisions described in the Plan must be fully implemented. The plan must be kept on file at the facility if it is attended at least eight hours daily. NCPCM’s Technical Director will assist (for a fee) in preparation of SPCC Plans. Contact NCPCM for further details.

Outline of SPCC Plan

- A. GENERAL DESCRIPTION**
- B. DESCRIPTION OF SPILL EVENTS WITHIN PAST 12 MONTHS**
- C. SPILL PREDICTIONS: DIRECTIONS, RATE OF FLOW, QUANTITY**
- D. GENERAL REQUIREMENTS: CONTAINMENT, DIVERSIONARY STRUCTURES**
- E. ALTERNATIVE STRONG OIL SPILL CONTINGENCY PLAN**
- F. SPECIFIC REQUIREMENTS**
 - 1. Drainage from containment structures
 - 2. Oil Storage Tanks
 - 3. Facility Transfer Operations
 - 4. Loading and Unloading Facilities
 - 5. Inspection and Test Records
 - 6. Security
 - 7. Personnel Training and Spill Prevention Procedures
 - 8. Precipitation Release Schedule

APPENDICES

- 1. Plot Drawing of Facility and Map
- 2. Certification of Substantial Harm Criteria Form

Engineering Services Provide by NCPCM

NCPCM’s Technical Affairs Director will provide engineering services for NCPCM members and non-members as time allows and per NCPCM’s Professional Engineering/Geology Policy (travel/lodging extra). NCPCM can also provide professional engineering services in Virginia. There are discounts available for more than one service. The typical services are as follows:

Service	*NCPDM Member Fee	Non Member Fee
US EPA Spill Plan Preparations	Please Call	Please Call
US EPA Spill Plan Amendments	Please Call	Please Call
US EPA Spill Contingency Plans per 112.7(d)	Please Call	Please Call
US EPA External AST inspection.	Please Call	Please Call
NC DWM Permits UST Form 6 and 6C with prints	Please Call	Please Call
US EPA Facility Response Plans, USCG Mobile Facility Response Plans	Please Call	Please Call
Virginia AST Oil Discharge Contingency Plan (ODCP)	Please Call	Please Call
Virginia Structural Engineering certification for secondary containment	Please Call	Please Call
Propane Fire Safety Analysis per NFPA-58, NC, VA, & SC.	Please Call	Please Call
NC DWQ General Stormwater Plans/Permits	Please Call	Please Call
NC Fire Code & DWM UST Engineering Permit Plans for Tanks. Concrete Pads/Dikes, Other Engineering items.	Please Call	Please Call

**NCPDM CATEGORY: Petroleum Marketer & Convenience Store Operator, dues payable by North Carolina Motor Fuel Sales Per Year. Large facilities may have increased engineering cost. Travel, meals, lodging, postage and printing may also be additional.*

SECONDARY CONTAINMENT VOLUME REQUIREMENTS FOR ASTs

The US EPA has established regulations requiring spill prevention and control for aboveground storage tanks greater than 1,320 gallons or two tanks with total capacity greater than 1320 gallons. Secondary containment can be dikes, berms, remote impounding or other various means. Dikes and berms must hold the single largest tank plus 10 percent for rainwater allowances. Another design criterion that can be used is the single largest tank plus the freeboard allowance factor. The freeboard allowance in NC is typically the minimum dike wall height to contain the single largest tank volume plus 6 inches. The dike floor is required to be coated, lined or has impermeable earth to prevent seepage. PLAN VIEW

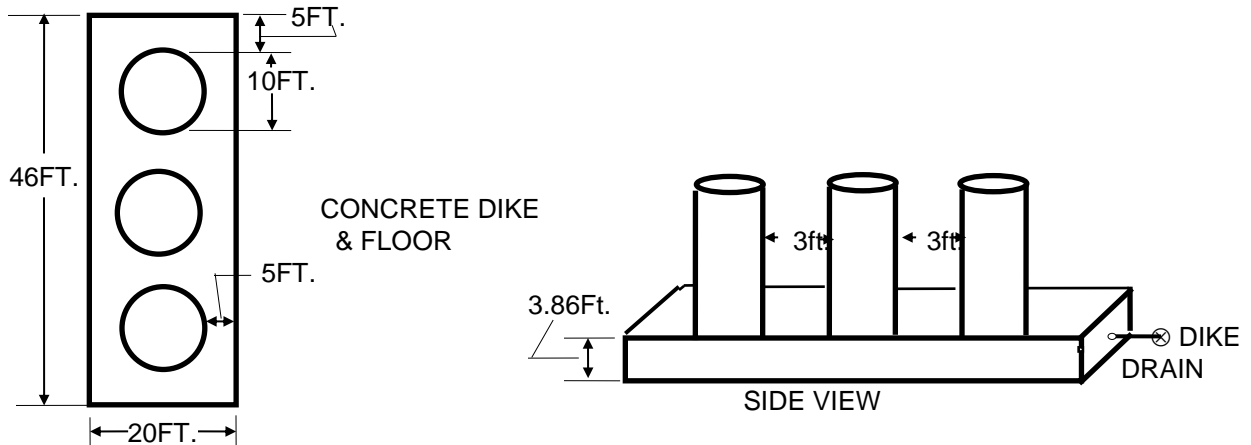

Consider the above drawing and example dike volume design procedure. We have three 20,000 gal. vertical tanks. Tanks are 10 Ft. in Diameter with a radius of 5 Ft., 5 Ft. from dike walls and 3 Ft. from each other. For our example we will add ten percent to the single largest tank which would equal 22,000 gals. Convert gallons to cubic feet by dividing gallons by 7.48 gals./cubic Ft. Therefore, 22,000 gals. ÷ 7.48 = 2942 Cubic Feet. The minimum area of the pad is 20 Ft. X 46 Ft. = 920 Square Feet. The other two tanks must be taken into consideration for their displacement area by calculating $\pi \times \text{radius squared} \times 2$ tanks. Therefore, $3.14 \times 5^2 \times 2 = 157 \text{ Ft.}^2$ Net dike available area, $920 \text{ Ft.}^2 - 157 \text{ Ft.}^2 = 763 \text{ Ft.}^2$ To determine dike wall height, divide 2942 Ft.^3 by $763 \text{ Ft.}^2 = 3.86 \text{ Ft.}$ or 3 Ft. 11 inches high.

Tanks should be kept at a minimum of 3 feet from the toe of the dike wall. Calculations for horizontal tanks would follow the same procedure. Horizontal tank ends must be kept a minimum of 3 feet inside dike wall.

EPA Toxic Release Inventory (TRI) Reporting Due

EPA TRI reporting requirements are mandatory for Bulk Petroleum Plants and Terminals with standard industrial classification code (SIC) 5171. TRI requires the operator of a covered facility to file an annual report documenting all releases of hazardous petroleum substances over the previous twelve-month period. Other chemicals, such as antifreeze (ethylene glycol) or brake fluids may also be include in the reporting requirements. The typical reportable release from bulk plants results from evaporation, fugitive emissions, and/or spills. The TRI reporting year on Form R or A, the report is due by July 1, 20--.

The following exemptions will apply: You just have to meet one of these to be exempt.

- **Your Bulk Plant facility is not a SIC code 5171.**
- **Your Bulk Plant facility is a SIC code 5171, but you have fewer than 10 employees. (20,000 hours worked)**
- **Is your SIC 5171 facility under the reporting threshold annual throughput? For gasoline the minimum throughput is about 60,000 gallons, for diesel and No. 2 fuel oil about 357,000 gallons, for K-1 about 275,000 gallons, for lube oil about 352,000 gallons.**

See <http://www.epa.gov/tri/>

BENZENE VAPOR RECOVERY RULE AT BULK GASOLINE PLANTS

On November 1, 1996 all Bulk Gasoline plants that have average daily throughputs greater than 2,500 gallons based on 312 days per year may be required to have vapor recovery at the loading rack. If over gasoline throughput, two criteria must be met to be determined if loading rack (outgoing) vapor recovery is required, Housing Density and County. **(1)** For Bulk Gasoline plants that are located in one of the following counties; **Alamance, Buncombe, Cabarrus, Catawba, Cumberland, Davidson, Durham, Forsyth, Gaston, Guilford, Mecklenburg, Orange, New Hanover, Rowan, and Wake**, and if the housing density is more than 50 residences within a one square mile area of the loading rack, then vapor recovery is required by Nov. 1, 1996. **(2)** In all other counties, the specified limit on housing density is 100 residences. All bulk gasoline plants over 4,000 gal. per day throughput gasoline must have vapor recovery on the outgoing without regard to housing density or location. All bulk gasoline plants must have vapor recovery on the incoming side regardless of gasoline throughput. Only UL rated pipe (plastic, fiberglass, or metal) can be used for vapor recovery. Underground piping should slope to a liquid trap in the event of gasoline vapor condensation. It has been estimated that cost of installation is between \$20,000 to \$45,000 for an average bulk plant with three tank wagons, plus maintenance cost estimated at \$1,000 per year.

TYPICAL BULK PLANT LAYOUT

MANIFOLD VAPOR RECOVERY PIPING & PRESSURE-VACUUM VENTS

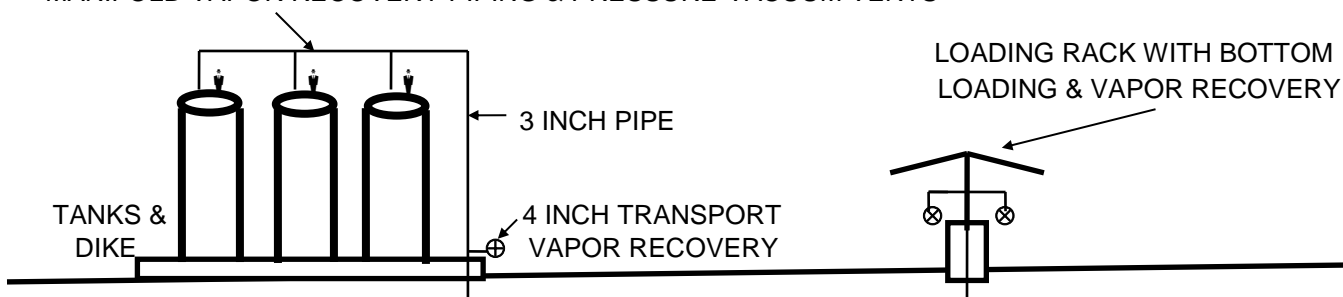

OSHA Confined Space Entry Program

Many of you may be using contractors at your AST/UST facilities to meet regulations. Host Employee (that's you) must ensure that OSHA Confined Space Entry Program is properly conducted by your subcontractors. Under Federal Regulation 29 CFR 1910.146(a): A "**confined space**" has limited or restricted means of entry or exit, is large enough for an employee to enter and perform assigned work, and is not designed for continuous occupancy by the employee. These spaces may include, but are not limited to, underground vaults, tanks, storage bins, pits/sumps and diked areas, vessels, and silos. A "**permit-required confined space**" is one that meets the definition of a confined space and has one or more of these characteristics: 1. contains or has the potential to contain a hazardous atmosphere, 2. contains a material that has the potential for engulfing an entrant, 3. has an internal configuration that might cause an entrant to be trapped or asphyxiated by inwardly converging walls or by a floor that slopes downward and tapers to a smaller cross section, and/or 4. contains any other recognized serious safety or health hazards.

Confined spaces may be classified into two categories: (1) open-topped enclosures with depths that restrict the natural movement of air (e.g., degreasers, pits, selected types of tanks/sumps and excavations), and (2) enclosures with limited openings for entry and exit (e.g., sewers, tanks and silo). Therefore all dikes, berms, sumps, pits and remote impounding areas and that have walls/depth over 4 feet in height are consider OSHA Confined Spaces.

1910.146(c)(1) The employer shall evaluate the workplace to determine if any spaces are permit-required confined spaces.

1910.146(c)(2) If the workplace contains permit spaces, the employer shall inform exposed employees, by posting danger signs or by any other equally effective means, of the existence and location of and the danger posed by the permit spaces. NOTE: A sign reading DANGER -- PERMIT-REQUIRED CONFINED SPACE, DO NOT ENTER or using other similar language would satisfy the requirement for a sign.

1910.146(c)(7) A space classified by the employer as a permit-required confined space may be reclassified as a non-permit confined space under the following procedures:

1910.146(c)(7)(i) If the permit space poses no actual or potential atmospheric hazards and if all hazards within the space are eliminated without entry into the space, the permit space may be reclassified as a non-permit confined space for as long as the non-atmospheric hazards remain eliminated.

1910.146(c)(7)(ii) If it is necessary to enter the permit space to eliminate hazards, such entry shall be performed under paragraphs (d) through (k) of this section. If testing and inspection during that entry demonstrate that the hazards within the permit space have been eliminated, the permit space may be reclassified as a non-permit confined space for as long as the hazards remain eliminated.

1910.146(c)(7)(iii) The employer shall document the basis for determining that all hazards in a permit space have been eliminated, through a certification that contains the date, the location of the space, and the signature of the person making the determination. The certification shall be made available to each employee entering the space or to that employee's authorized representative.

1910.146(c)(7)(iv) If hazards arise within a permit space that has been declassified to a non-permit space under paragraph (c)(7) of this section, each employee in the space shall exit the space. The employer shall then reevaluate the space and determine whether it must be reclassified as a permit space, in accordance with other applicable provisions of this section.

1910.146(c)(8) When an employer (**host employer**) arranges to have employees of another employer (**contractor**) perform work that involves permit space entry, the host employer shall:

1910.146(c)(8)(i) Inform the contractor that the workplace contains permit spaces and that permit space entry is allowed only through compliance with a permit space program meeting the requirements of this section;

1910.146(c)(8)(ii) Apprise the contractor of the elements, including the hazards identified and the host employer's experience with the space, that make the space in question a permit space;

1910.146(c)(8)(iii) Apprise the contractor of any precautions or procedures that the host employer has implemented for the protection of employees in or near permit spaces where contractor personnel will be working;

1910.146(c)(8)(iv) Coordinate entry operations with the contractor, when both host employer personnel and contractor personnel will be working in or near permit spaces, as required by paragraph (d)(11) of this section; and

1910.146(c)(8)(v) Debrief the contractor at the conclusion of the entry operations regarding the permit space program followed and regarding any hazards confronted or created in permit spaces during entry operations.

For a complete review of the regulations go to the below web site:

http://www.osha.gov/pls/oshaweb/owadisp.show_document?p_table=STANDARDS&p_id=9797

Stage II Vapor Recovery Repealed by Division of Air Quality (DAQ)

After January 1, 2009, NC DAQ will no longer require Stage II Vapor Recovery in North Carolina. On December 18, 2008, the Rules Review Commission (RRC) approved a number of air quality rule amendments, adoptions and repeals that became effective on January 1, 2009.

NC DAQ Regulations: 15A NCAC 02D .0953 VAPOR RETURN PIPING FOR STAGE II VAPOR RECOVERY & 15A NCAC 02D .0954 STAGE II VAPOR RECOVERY are no longer required for the entire state of North Carolina.

No new installations have to install the Stage II piping from the dispensers back to the tank(s). Existing systems may be removed or capped off in a safe manner. Testing of existing Stage II systems is no longer required.

Local Air Pollution Programs still have the authority to require Stage II systems.

Stage I Vapor Recovery is still in effect and is state wide.

STAGE I VAPOR RECOVERY CONTROLS

15A NCAC, 2D-.0928 Stage I vapor recovery is required on all service stations/gasoline dispensing facilities that have annual throughputs greater than 50,000 gallons per year. All gasoline tanks and tankers must be submerged filled or bottom loaded regardless of gasoline throughput. Submerged fill tubes can be 12 inches off the bottom of the tank if the tank has a poppeted vapor recovery adapter. Farm and residential tanks of not more than 2000 gallons may use a portable submerged fill tube. If an unpoppeted vapor recovery adapter is used, the unpoppeted vapor recovery adapter shall be replaced with a poppeted vapor recovery adapter when the tank is new, replaced or upgraded. Where vapor recovery lines are manifolded, then poppeted vapor adapters are to be used. No more than one tank is to be loaded at a time if the manifolded vapor lines are less than 2.5 inches in size. Vent lines must have pressure release valves. Exemptions include stationary tanks of not more than 2000 gallons which were in place before July 1, 1979, and stationary tanks not over 550 gallons in place after June 30, 1979, (submerged fill tubes required). Effective date is November 1, 1992, and July 1, 1994.

Convenience Store Employee Supervision of Refueling Operations in Accordance with NC Fire Codes

From Chapter 23 of the NC Fire Code:

2304.1 Supervision of dispensing.

The dispensing of fuel at motor fuel-dispensing facilities shall be conducted by a qualified attendant or shall be under the supervision of a qualified attendant at all times or shall be in accordance with Section 2304.3.

❖ Motor fuel-dispensing facilities must have a trained, qualified attendant on duty when the facility is open for business, unless the fire code official specifically approves an unattended location.

2304.2 Attended self-service motor fuel-dispensing facilities.

Attended self-service motor fuel-dispensing facilities shall comply with Sections 2304.2.1 through 2304.2.5. Attended self-service motor fuel-dispensing facilities shall have at least one qualified attendant on duty while the facility is open for business. The attendant's primary function shall be to supervise, observe and control the dispensing of fuel. The attendant shall prevent the dispensing of fuel into containers that do not comply with Section 2304.4.1, control sources of ignition, give immediate attention to accidental spills or releases, and be prepared to use fire extinguishers.

❖ An attendant trained in spill control, ignition source control, recognizing approved fuel containers and fire extinguishment is required to be in visual contact with the dispensing operation when the motor fuel-dispensing facility is open for business unless the fire code official has given approval for an unattended self-service facility. The attendant may perform other duties such as those of cashier so long as the attendant can supervise the dispensing operation and has immediate access to emergency shutoff controls. Note that the responsibility of supervision, observation and control of the dispensing operations includes enforcement of the procedures and rules in Sections 2305.6 and 2310.5.

2305.6 Warning signs.

Warning signs shall be conspicuously posted within sight of each dispenser in the fuel-dispensing area and shall state the following:

- 1. It is illegal and dangerous to fill unapproved containers with fuel.**
- 2. Smoking is prohibited.**
- 3. The engine shall be shut off during the refueling process.**
- 4. Portable containers shall not be filled while located inside the trunk, passenger compartment, or truck bed of a vehicle.**

❖ The warning sign must be legible and conspicuously posted in the dispensing area. The intent is to notify the dispenser operator not to use unapproved fuel containers, to remove portable containers from the vehicle before filling (see commentary, Section 2304.4.3) and to eliminate ignition source, such as smoking and operating internal combustion engines. The warnings should be on a sign with a contrasting background that will catch the eye of the person performing the dispensing operation.

The NC Fire Code Chapter 50 HAZARDOUS MATERIALS - GENERAL PROVISIONS

5001.1 Scope: Prevention, control and mitigation of dangerous conditions related to storage, dispensing, use and handling of hazardous materials shall be in accordance with this chapter. This chapter shall apply to all hazardous materials, including those materials regulated elsewhere in this code, except

that when specific requirements are provided in other chapters, those specific requirements shall apply in accordance with the applicable chapter.

5001.1.1 Waiver: *The provisions of this chapter are waived when the code official determines that such enforcement is preempted by other codes, statutes or ordinances. The details of any action granting such a waiver shall be recorded and entered in the files of the code enforcement agency.*

The Code official may require convenience stores to develop a Hazardous Materials Management Plan (5001.4.1) and or Hazardous Materials Inventory Statement (5001.4.2).

Convenience Store Employee Training on Petroleum Spills & Fire Emergencies

OSHA and the NC Fire Code require convenience store employees have training on petroleum spills and fire emergencies. DO NOT WASH/HOSE DOWN PETROLEUM SPILLS REGARDLESS OF QUANTITY SPILLED. No oil sheen is to leave the property. For small spills apply absorption products that can be cleaned up and disposed of properly.

OSHA's 1910.38 EMPLOYEE EMERGENCY PLANS AND FIRE PREVENTION PLANS

If convenience stores have 10 or fewer employees then a common plan could be developed to orally communicate to the store employees. **Emergency Action Plan & Fire Prevention Plan:** **The plan shall be in writing except with 10 or fewer employees (per Facility) the plan may be communicated orally and the employer need not maintain a written plan on site.** The elements of a plan shall be: (A) Emergency escape procedures and escape routes. (B) Procedures for employees who must remain behind to operate critical plants operations before they evacuate. (C) Procedures to account for all employees after emergency evacuation. (D) Rescue and medical duties for those employees designated to perform them. (E) The preferred means of reporting fires and other emergencies. (F) Names, phone numbers, of persons, departments who can be contacted for other information or explanation of the plan.

1) Employer alarm system that complies with 1910.165: For convenience stores this can be designated employee visual site of emergency.

2) Evacuation: The employer must establish in the plan the types of evacuation to be used in emergencies.

3) Training: The employer shall designate and train a sufficient number of persons to assist in the safe and orderly evacuation of other persons. The employer must review the plan with each employee before the plan is initially developed, whenever the employee's responsibilities change, & whenever the plan is changed. The employer shall apprise employees of the fire hazards of the materials and fire hazards to which they are exposed. The employer shall review with each employee the parts of the plan which the employee must know to protect the employee in the event of a fire emergency. **Small petroleum spills in unconfined spaces that do not exceed chemical exposure limits may be cleaned up by non-OSHA trained personnel.**

4) Housekeeping: The employer shall control the accumulation of flammable and combustible waste materials so that they do not contribute to a fire emergency. Housekeeping procedures shall be incorporated in the fire prevention plan.

5) Maintenance: The employer shall regularly and properly maintain all equipment and systems installed on heat producing equipment to prevent accidental ignition of combustible materials. The maintenance procedures shall be part of the written plan.

THE NORTH CAROLINA HAZARD COMMUNICATION STANDARD UNDER OSHA ("EMPLOYEE RIGHT TO KNOW") Acting from Federal Regulation 29 CFR 1910.1200

APPLICABILITY: The Hazard Communication Standard (HCS) is based on a simple concept-that employees have a need and a right to know the hazards and identities of the chemicals they are exposed to when working. For example, at a retail facility such as a convenience store where all hazardous chemicals are in sealed containers, then there is no requirement for a HCS. However, if an employee gauges the USTs with a stick, then they would or cleans up spills, they will be exposed and that facility would require a HCS.

North Carolina Law Article 21A: Oil Pollution and Hazardous Substances Control.

Requires proper oil spill reporting and disposal of spills & clean up materials. For full text of law go to

http://h2o.enr.state.nc.us/admin/rules/documents/StatutesMay2004_000.doc#_Toc73243915

§143-215.85. Required notice.

(b) As used in this subsection, "petroleum" has the same meaning as in G.S. 143-215.94A. A person who owns or has control over petroleum that is discharged into the environment shall immediately take measures to collect and remove the discharge, report the discharge to the Department within 24 hours of the discharge, and begin to restore the area affected by the discharge in accordance with the requirements of this Article if the volume of the

petroleum that is discharged is 25 gallons or more or if the petroleum causes a sheen on nearby surface water or if the petroleum is discharged at a distance of 100 feet or less from any surface water body. **If the volume of petroleum that is discharged is less than 25 gallons, the petroleum does not cause a sheen on nearby surface water, and the petroleum is discharged at a distance of more than 100 feet from all surface water bodies, the person who owns or has control over the petroleum shall immediately take measures to collect and remove the discharge.** If a discharge of less than 25 gallons of petroleum cannot be cleaned up within 24 hours of the discharge or if the discharge causes a sheen on nearby surface water, the person who owns or has control over the petroleum shall immediately notify the Department.

Accidental Mixing of Different Fuel Types

Remember the 1% correct **rule of thumb** for distillate fuels and gasoline blends. This equate to blending 1 gallon per every 100 gallons. For light distillates (Kerosene) mixed with medium distillates (Diesel/Fuel Oil) use **1.5% to 2% rule of thumb**. Consider that you accidentally dropped 200 gallons of diesel into 4,200 gallons of gasoline. To correct the problem, that is changing the entire mix to gasoline, divide 200 by 1% (0.01) equals 20,000. Take 4,200 (original gasoline) from 20,000 equals 15,800. Therefore, you would need an additional 15,800 gallons of gasoline added to the mix to met specs.

For large accidental mixes, it is recommend to pump out and take back to terminal. Consider you dropped 1,000 gallons of gasoline into 10,000 gallons of Diesel. You would have to add 90,000 gallons to the blend of 11,000 gallons to meet spec. Remember, this is a **Rule of Thumb** correction. **You could potentially make a correction with the above ratios and still be out of spec.**

You should also call NCDA-CS (919-733-3313) for more accurate field testing, before selling to the public.
(TL)

API Color Symbols System for Proper ID of Fuel Storage Tanks, Fills & Piping

The industry standard color code is provided via the American Petroleum Institute (API). API Standard 1637-**USING THE API COLOR-SYMBOL SYSTEM TO MARK EQUIPMENT AND VEHICLES FOR PRODUCT IDENTIFICATION AT GASOLINE DISPENSING FACILITIES AND DISTRIBUTION TERMINALS.** (3rd Edition July 2006). Contact API at www.api.org for copy of standard. **COPYRIGHTED MATERIAL**

The IFC Fire Code requires each fill pipe for motor fuel at a service station must have a label or must be painted a particular color to represent the product in the tank. Furthermore, there must be a key or code chart for such color painting available inside the station office and every employee should be aware of the location of the color code at the station. NIST Handbook 44 also requires an ID system in place. If color code is used, a color chart is required at the place of business where it can be easily seen, preferably where it can be seen from the tanks. If a Standards Division Inspector (NCDA-CS) visits the station they must be able to determine what fill pipe represents what product and there must be a (color code) chart available to spell it out. Just using "memory" will not suffice.

As to what colors are best for the various fuels sold - each company can use their own scheme but the recommendations of the American Petroleum Institute (API) are shown on this page. **Anytime there is the slightest doubt as to color codes or what products that customer has "stop and call dispatch". SEE CHART BELOW**
SAMPLE COLOR CODE CHART

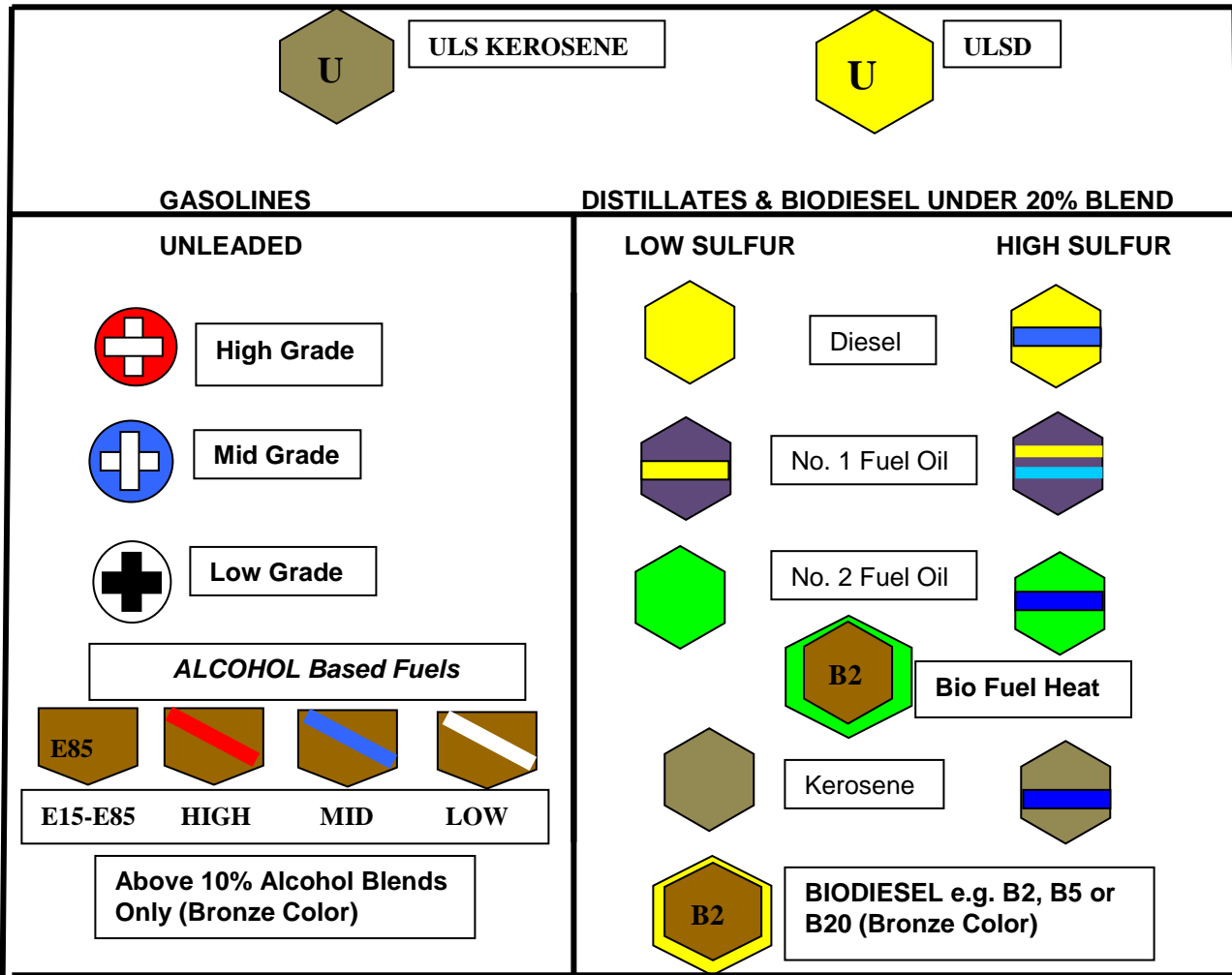

USED OIL

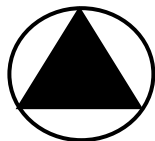

OBSERVATION WELL

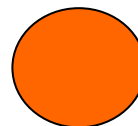

VAPOR RECOVERY